

BESTLIFT™

NEW!

PL228 | FULL BODY PATIENT LIFT

The BestLift™ PL228 is the perfect blend of form and function for patient transfers. With an overall base length of 44.9", maximum width of 42.9", and base height of 4.5", it is the perfect solution for transferring bariatric patients in small rooms with low beds.



- **500lb** capacity
- Dual front castors
- New electronics with 24/7 capability
- New hand operated base opening

| PL228



| DIMENSIONS

Key dimensions of PL228	
maximum capacity	500Lb / 228Kg
base legs length	44.9"
base closed external width	24.9"
based open external width	42.9"
mast height	48.3"
base height	4.5"
min. lifting height	25.8"
max. lifting height	69.1"
net weight	99Lb / 45Kg
shipping weight	108Lb / 49Kg

*** SPECIFICATIONS PROVIDED ARE A GENERAL GUIDELINE AND ARE SUBJECT TO CHANGE WITHOUT NOTICE**



2920 PACIFIC DR., NORCROSS, GA 30071
 WWW.BESTCARELLC.COM
 678-679-6690

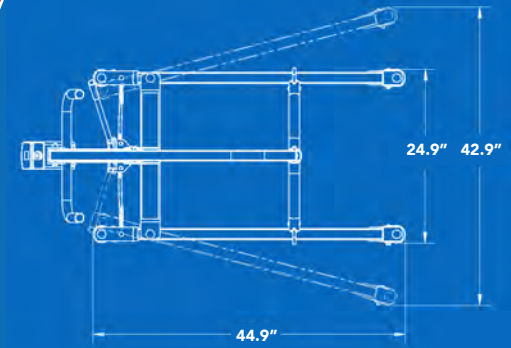

TOP VIEW OF PL228

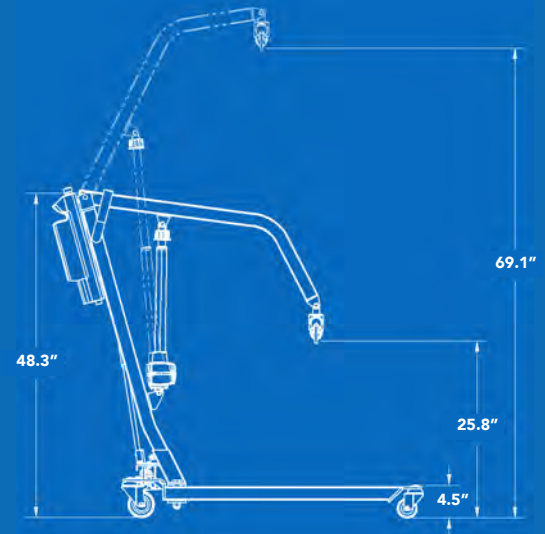

SIDE VIEW OF PL228